

High Pressure Filter

Pi 4000

Operating pressure 400 bar, Nominal size up to 400
according DIN 24550

1. Features

Efficient filters for modern hydraulic systems

- Modular design principle
- Compact design
- Minimal pressure drop
- Optical/electrical/electronic contamination control
- Threaded or SAE flange connection

Quality filters, easy to service

- Equipped with highly efficient Sm-x filter elements
- β -valued elements per ISO 16889
- High dirt holding capacity and differential pressure stability providing optimal element service life

Worldwide distribution



2. Flow rate/pressure drop curve complete filter

■ 190 mm²/s (25° E)
■ 33 mm²/s (4,5° E)

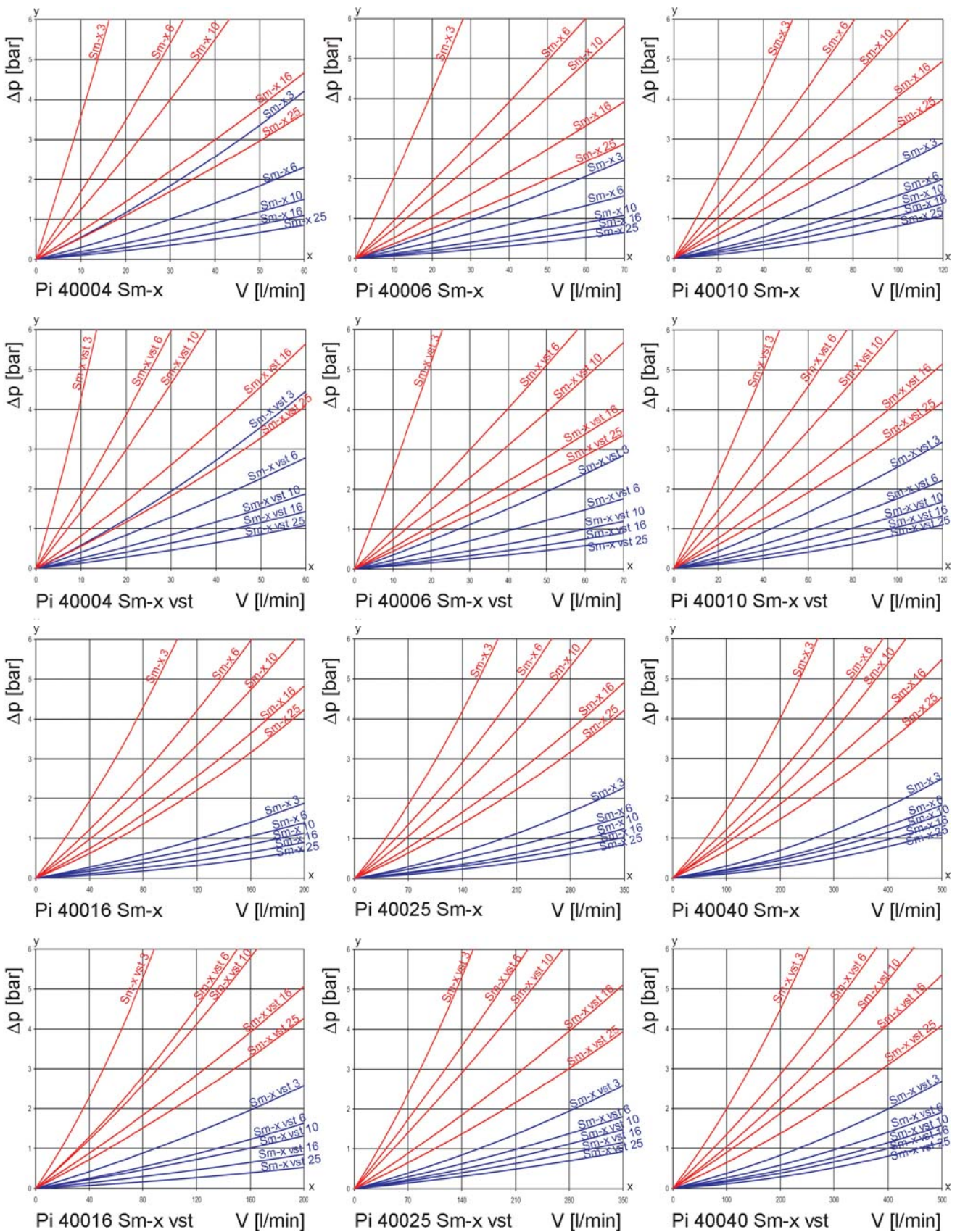

y = differential pressure Δp [bar]

x = flow rate V [l/min]

3. Separation characteristics

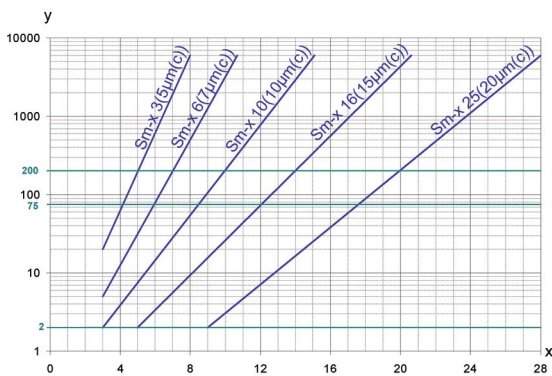

y = beta-ratio
x = particle size [μm]

determined by multipass test (ISO 16889)
calibration according to ISO 11171 (NIST)

4. Filter performance data

measured according to ISO 16889 (multipass test)

Sm-x elements with
 Δp 20 bar

Sm-x	3	$\beta_{5(C)} \geq 200$
Sm-x	6	$\beta_{7(C)} \geq 200$
Sm-x	10	$\beta_{10(C)} \geq 200$
Sm-x	16	$\beta_{15(C)} \geq 200$
Sm-x	25	$\beta_{20(C)} \geq 200$

up to 10 bar differential
pressure

Sm-x vst elements with
 Δp 210 bar

Sm-x vst	3	$\beta_{5(C)} \geq 200$
Sm-x vst	6	$\beta_{7(C)} \geq 200$
Sm-x vst	10	$\beta_{10(C)} \geq 200$
Sm-x vst	16	$\beta_{15(C)} \geq 200$
Sm-x vst	25	$\beta_{20(C)} \geq 200$

up to 20 bar differential
pressure

5. Quality assurance

MAHLE filter and filter elements are manufactured respectively, tested in accordance with the following international standards:

Norm	Designation
DIN ISO 2941	Hydraulic fluid power filter elements; verification of collapse/burst resistance
DIN ISO 2942	Hydraulic fluid power filter elements; verification of fabrication integrity
DIN ISO 2943	Hydraulic fluid power filter elements; verification of material compatibility with fluids
DIN ISO 2923	Hydraulic fluid power filter elements; method for end load test
DIN ISO 2924	Hydraulic fluid power filter elements; verification of flow fatigue characteristics
ISO 3968	Hydraulic fluid power filters; evaluation of pressure drop versus flow characteristics
ISO 10771.1	Fatigue pressure testing of metal containing envelopes in hydraulic fluid applications
ISO 16889	Hydraulic fluid power filters; multipass method for evaluation filtration performance of a filter element

6. Symbols

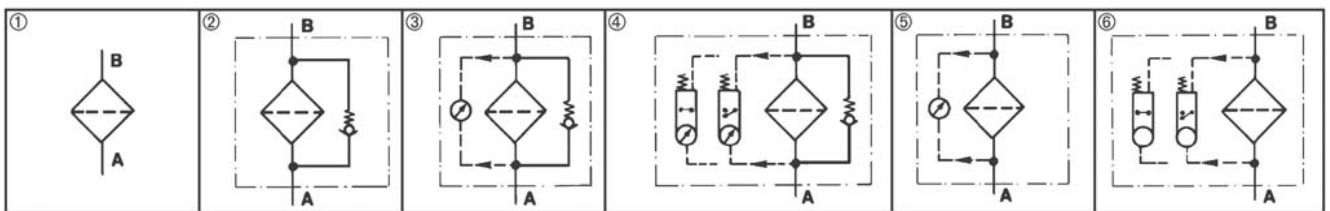

7. Order numbers

Example for ordering filters:

1. Housing design	2. Filter element
Housing design V = 100 l/min and electrical indicator Type: Pi 40010-15, Order number: 77978448	Sm-x vst 3 Type: Pi 71010 DN Sm-x vst 3, Order number: 78227480

7.1 Housing design								
Nominal size NG [l/min]	Order number	Type	① with indicator cavity	② with bypass valve and indicator cavity	③ with bypass valve and optical indicator	④ with bypass valve and electrical indicator	⑤ with optical indicator	⑥ with electrical indicator
40	78207201	Pi 40004-010						
	78207219	Pi 40004-011						
	78207227	Pi 40004-012						
	78304156	Pi 40004-013						
	78207243	Pi 40004-014						
	77978463	Pi 40004-015						
63	78207268	Pi 40006-010						
	78207276	Pi 40006-011						
	78207284	Pi 40006-012						
	78304164	Pi 40006-013						
	78207300	Pi 40006-014						
	77978455	Pi 40006-015						
100	78207326	Pi 40010-010						
	78207334	Pi 40010-011						
	78207342	Pi 40010-012						
	78304172	Pi 40010-013						
	78207367	Pi 40010-014						
	77978448	Pi 40010-015						
160	78207833	Pi 40016-010						
	78207391	Pi 40016-011						
	78207409	Pi 40016-012						
	78304107	Pi 40016-013						
	78207425	Pi 40016-014						
	78207433	Pi 40016-015						
250	78207458	Pi 40025-010						
	78207466	Pi 40025-011						
	78207474	Pi 40025-012						
	78304115	Pi 40025-013						
	78207490	Pi 40025-014						
	78207813	Pi 40025-015						
400	78207821	Pi 40040-010 FL						
	78207839	Pi 40040-011 FL						
	78207847	Pi 40040-012 FL						
	78304123	Pi 40040-013 FL						
	78207862	Pi 40040-014 FL						
	78207870	Pi 40040-015 FL						

When filter with non bypass configuration is selected the collapse pressure of the element may not be exceeded.

7.2 Filter elements*					
Nominal size NG [l/min]	Order number	Type	Filter material	Collapse pressure [bar]	Filter surface [cm ²]
40	78260929	Pi 21004 DN Sm-x 3	Sm-x 3	20	475
	77690859	Pi 22004 DN Sm-x 6	Sm-x 6		475
	77925571	Pi 23004 DN Sm-x 10	Sm-x 10		475
	78260937	Pi 24004 DN Sm-x 16	Sm-x 16		475
	78260945	Pi 25004 DN Sm-x 25	Sm-x 25		475
	78216079	Pi 71004 DN Sm-x vst 3	Sm-x vst 3	210	445
	77960156	Pi 72004 DN Sm-x vst 6	Sm-x vst 6		445
	77925654	Pi 73004 DN Sm-x vst 10	Sm-x vst 10		445
	78216087	Pi 74004 DN Sm-x vst 16	Sm-x vst 16		445
	78216095	Pi 75004 DN Sm-x vst 25	Sm-x vst 25		445
63	78260960	Pi 21006 DN Sm-x 3	Sm-x 3	20	835
	77960867	Pi 22006 DN Sm-x 6	Sm-x 6		835
	77925589	Pi 23006 DN Sm-x 10	Sm-x 10		835
	78260978	Pi 24006 DN Sm-x 16	Sm-x 16		835
	78260986	Pi 25006 DN Sm-x 25	Sm-x 25		835
	78216137	Pi 71006 DN Sm-x vst 3	Sm-x vst 3	210	780
	77960149	Pi 72006 DN Sm-x vst 6	Sm-x vst 6		780
	77925662	Pi 73006 DN Sm-x vst 10	Sm-x vst 10		780
	78216145	Pi 74006 DN Sm-x vst 16	Sm-x vst 16		780
	78216152	Pi 75006 DN Sm-x vst 25	Sm-x vst 25		780
100	78227472	Pi 21010 DN Sm-x 3	Sm-x 3	20	1375
	77960875	Pi 22010 DN Sm-x 6	Sm-x 6		1375
	77925597	Pi 23010 DN Sm-x 10	Sm-x 10		1375
	78261000	Pi 24010 DN Sm-x 16	Sm-x 16		1375
	78261018	Pi 25010 DN Sm-x 25	Sm-x 25		1375
	78227480	Pi 71010 DN Sm-x vst 3	Sm-x vst 3	210	1275
	77960131	Pi 72010 DN Sm-x vst 6	Sm-x vst 6		1275
	77925670	Pi 73010 DN Sm-x vst 10	Sm-x vst 10		1275
	78261281	Pi 74010 DN Sm-x vst 16	Sm-x vst 16		1275
	78216160	Pi 75010 DN Sm-x vst 25	Sm-x vst 25		1275

7.2 Filter elements*					
Nominal size NG [l/min]	Order number	Type	Filter material	Collapse pressure [bar]	Filter surface [cm ²]
160	78261034	Pi 21016 DN Sm-x 3	Sm-x 3	20	2530
	77960826	Pi 22016 DN Sm-x 6	Sm-x 6		2530
	77925605	Pi 23016 DN Sm-x 10	Sm-x 10		2530
	78261042	Pi 24016 DN Sm-x 16	Sm-x 16		2530
	78261059	Pi 25016 DN Sm-x 25	Sm-x 25		2530
	77940638	Pi 71016 DN Sm-x vst 3	Sm-x vst 3	210	1885
	77960123	Pi 72016 DN Sm-x vst 6	Sm-x vst 6		1885
	77925688	Pi 73016 DN Sm-x vst 10	Sm-x vst 10		1885
	78269797	Pi 74016 DN Sm-x vst 16	Sm-x vst 16		1885
	78216178	Pi 75016 DN Sm-x vst 25	Sm-x vst 25		1885
250	78227514	Pi 21025 DN Sm-x 3	Sm-x 3	20	4020
	77960834	Pi 22025 DN Sm-x 6	Sm-x 6		4020
	77925613	Pi 23025 DN Sm-x 10	Sm-x 10		4020
	78261075	Pi 24025 DN Sm-x 16	Sm-x 16		4020
	78261083	Pi 25025 DN Sm-x 25	Sm-x 25		4020
	77940646	Pi 71025 DN Sm-x vst 3	Sm-x vst 3	210	3090
	77960115	Pi 72025 DN Sm-x vst 6	Sm-x vst 6		3090
	77925696	Pi 73025 DN Sm-x vst 10	Sm-x vst 10		3090
	78269813	Pi 74025 DN Sm-x vst 16	Sm-x vst 16		3090
	78216186	Pi 75025 DN Sm-x vst 25	Sm-x vst 25		3090
400	78227522	Pi 21040 DN Sm-x 3	Sm-x 3	20	6770
	77960842	Pi 22040 DN Sm-x 6	Sm-x 6		6770
	77925621	Pi 23040 DN Sm-x 10	Sm-x 10		6770
	78261109	Pi 24040 DN Sm-x 16	Sm-x 16		6770
	78261117	Pi 25040 DN Sm-x 25	Sm-x 25		6770
	77940653	Pi 71040 DN Sm-x vst 3	Sm-x vst 3	210	5240
	77960107	Pi 72040 DN Sm-x vst 6	Sm-x vst 6		5240
	77930829	Pi 73040 DN Sm-x vst 10	Sm-x vst 10		5240
	78269821	Pi 74040 DN Sm-x vst 16	Sm-x vst 16		5240
	78260903	Pi 75040 DN Sm-x vst 25	Sm-x vst 25		5240

* further elements available upon request

8. Specifications

Design:	line mounting filter
Operating pressure:	400 bar
Test pressure:	520 bar
Temperature range:	-10 °C to +120 °C (other temperature ranges on request)
Bypass opening pressure:	Δp 7 bar \pm 10 %
Filter head material:	GGG
Filter bowl material:	St
Sealing material:	NBR/PTFE
Activating pressure of optical/ electrical differential pressure indicator:	Δp 5 bar \pm 10 %
Electrical data of contamination indicator:	
Maximum voltage:	250 V AC/200 V DC
Maximum current on contact	1 A
Inrush current:	70 W
Type of protection:	IP 65 when inserted and secured
Contact:	bistable
Cable connection:	M 20 x 1.5

The switching function can be changed by turning the electric upper part by 180° (normally closed contact or normally open contact). The state on delivery is a normally closed contact. The use of quenching circuits must be checked in the case of inductivity in the DC current circuit. The contamination indicator data sheet contains further information and additional contamination indicator versions.

We draw attention to the fact that all values indicated are average values which do not always occur in specific cases of application. Our products are continually being further developed. Values, dimensions and weights can change as a result of this. Our specialized department will be pleased to offer you advice.

When using our filters in areas which are to be classified according to EU Directive 94/9 EG (ATEX 95), we recommend prior discussion with us. The standard version can be used for liquids based on mineral oil (corresponding to the fluids in Group 2 of Directive 97/23 EG article 9). Please consult with us if using other media.

Subject to technical alteration without prior notice.

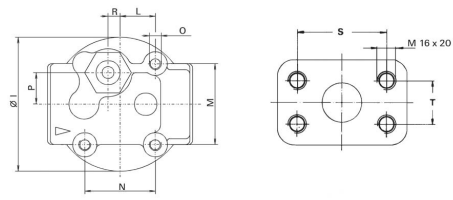

NG 40 - 100

DN 38 according to SAE 1½" 6000 psi
flanges, bolts, o-rings not
included in delivery

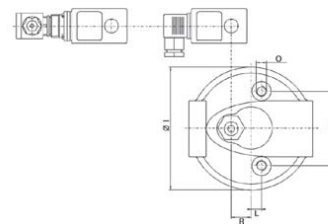
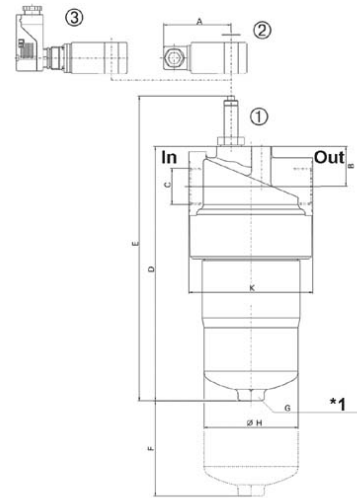

In = inlet

Out = outlet

*1 NG 250, 400 with drain screw G ¼ DIN 910

- Pos. 1 Optical contamination indicator
Pos. 2 Electrical upper section connector according
DIN EN 175301-803
Executions: PiS 3092, 9105, 3115
Pos. 3 Electrical upper section connector according
DIN EN 175301-804
Executions: PiS 3102, 3122, 3110

9. Dimensions

All dimensions except "C" in mm.

Type	A	B	C	D	E	F	G SW	H	I	K	L	M	N	O	P	R	S	T	Weight [kg]
Pi 40004	78	31	G½	194	252	80	27	66	90	92	23.5	54	47	M 8 x 16	21	8	-	-	4.2
Pi 40006	78	31	G¾	254	313	80	27	66	90	92	23.5	54	47	M 8 x 16	21	8	-	-	4.9
Pi 40010	78	31	G 1	344	402	80	27	66	90	92	23.5	54	47	M 8 x 16	21	8	-	-	5.8
Pi 40016	78	46	G 1¼	294	352	110	30	109	142	143.5	12	86	-	M 12 x 15	-	23	-	-	12.6
Pi 40025	78	46	G 1½	394	452	110	30	109	142	143.5	12	86	-	M 12 x 15	-	23	-	-	14.2
Pi 40040 FL	78	46	DN 38	544	602	110	20	109	142	143.5	12	86	-	M 12 x 15	-	23	79.4	36.5	18.4

10. Installation, operating and maintenance instructions

10.1 Filter installation

When installing the filter make sure that sufficient space is available to remove filter element and filter bowl. Preferable the filter should be installed with the filter bowl pointing downwards. The contamination indicator must be visible.

10.2 Connecting the electrical contamination indicator

The electrical indicator is connected via a 2-pole appliance plug according to DIN EN 175301-803 with poles marked 1 and 2.

The electrical section can be inverted to change from normally open position to normally closed position or vice versa.

10.3 When must the filter element be replaced?

- Filters equipped with optical and electrical contamination indicator:
During cold starts, the indicator may give a warning signal. Depress the red button of the visual indicator once again only after operating temperature has been reached. If the red button immediately pops out again and/or the electrical signal has not switched off after reaching operating temperature, the filter element must be replaced after the end of the shift.
- Filters without contamination indicator:
The filter element should be replaced after the trial run or flushing of the system. Afterwards follow instructions of the manufacturer.
- Please always ensure that you have Original MAHLE replacement elements in stock: disposable elements (Sm-x) cannot be cleaned.

10.4 Element replacement

- Stop system and relieve filter from pressure.
- Unscrew the filter bowl by turning counter-clockwise. Clean the bowl using a suitable cleaning solvent.
- Remove the filter element with a side-to-side motion.
- Check o-ring and spigot for damage. Replace, if necessary.
- Make sure that the order number on the spare element corresponds with the order number of the plate. Remove the plastic bag and push element over the spigot in the filter head.
- Complete installation by screwing on the bowl, turning clockwise until it comes to a full stop. Back off the bowl 1/8 to 1/2 turn.

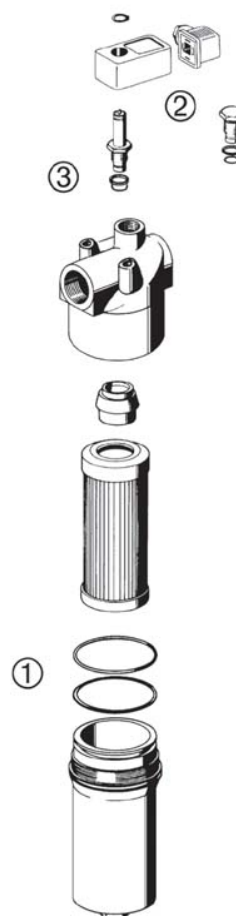

MAHLE Filtersysteme GmbH
Industriefiltration
Schleifbachweg 45
D-74613 Öhringen
Phone +49 (0) 7941/67-0
Fax +49 (0) 7941/67-23429
industriefiltration@mahle.com
www.mahle-industrialfiltration.com
78396038.11/2006

11. Spare parts list

Order numbers for spare parts		
Position	Type	Order number
①	Seal kit	
	Pi 40004 - Pi 40010	
	NBR	78383804
	FPM	78383812
	EPDM	78383820
	Pi 40016 - Pi 40040	
	NBR	78383838
	FPM	78383846
	EPDM	78383853
②	Contamination indicator	
	Optical PiS 3093/5	77669914
	Electrical PiS 3092/5	77669864
	Electrical upper section only	77536550
③	Seal kit for contamination indicator	
	NBR	77760275
	FPM	77760283
	EPDM	77760291