

FLAT GAGES

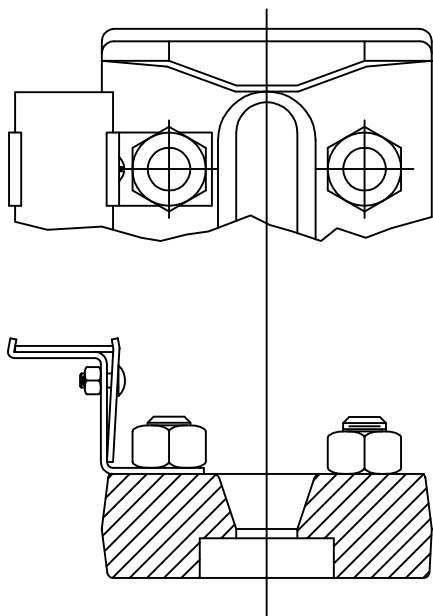

MOUNTING BRACKET FOR USE ON FLAT GAGES

TUBULAR GAGES

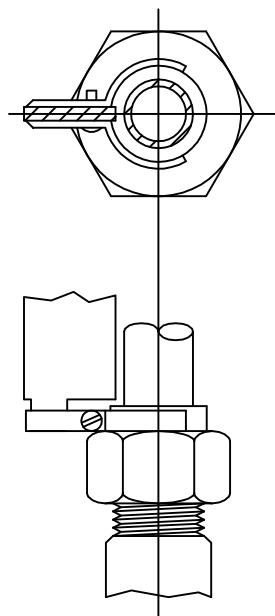

MOUNTING CLAMP FOR USE ON TUBULAR GLASS

TYPES AVAILABLE

TYPE 1 - CAMPBELL'S FOOT SCALE, PRESSURE CAST, WEATHER RESISTANT ZINC ALLOY, FURNISHED IN IDENTICAL ONE FOOT STRIPS WITH NUMBERED COUPLING PLATES TO BE ASSEMBLED BY CUSTOMER TO ANY DESIRED LENGTH. (SEE NOTE 1) GRADUATED IN FEET, INCHES, & EIGHTHS OF AN INCH.

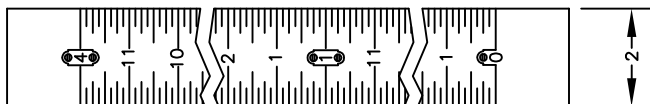

TYPE 2 - LAMINATED PLASTIC SCALE, WHITE ENGRAVED NUMERALS & GRADUATIONS ON BLACK SURFACE. GRADUATED TO SPECIFICATION, MAX. NUMBER OF GRADUATIONS, 10 PER INCH. (SEE NOTE 2)

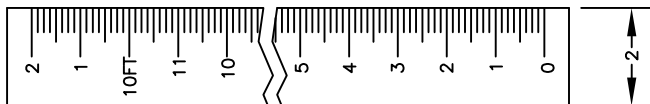

TYPE 3 - ENGRAVED METAL SCALE, UNPAINTED BRASS, ALUMINUM, OR STAINLESS STEEL. ENGRAVED NUMERALS & GRADUATIONS ARE BLACK ENAMEL FILLED. GRADUATED TO SPECIFICATION.

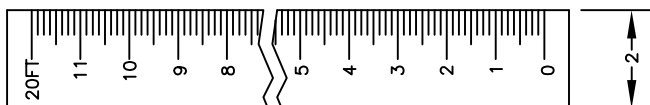

TYPES AVAILABLE

TYPE 5 - LAMINATED PLASTIC SCALE, WHITE ENGRAVED NUMERALS & GRADUATIONS ON BLACK SURFACE. GRADUATED TO SPECIFICATION, MAX. NUMBER OF GRADUATIONS, 10 PER INCH. (SEE NOTE 2)

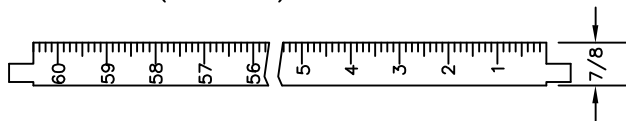

TYPE 6 - ENGRAVED METAL SCALE, UNPAINTED BRASS, ALUMINUM, OR STAINLESS STEEL. ENGRAVED NUMERALS & GRADUATIONS ARE BLACK ENAMEL FILLED. GRADUATED TO SPECIFICATION.

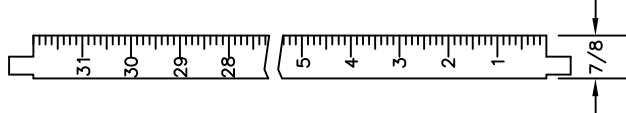

NOTES:

1. SCALES MAY BE FURNISHED WITH SCREW HOLES FOR MOUNTING ON A WOODEN GAGE BOARD. WHEN MOUNTING BRACKETS ARE ORDERED, SCALES ARE FURNISHED WITH MACHINE SCREWS FOR ASSEMBLY.
2. LAMINATED PLASTIC SCALES OVER 40" LONG WILL BE FURNISHED IN MULTIPLE SECTIONS BECAUSE OF SIZE LIMITATIONS OF RAW STOCK.
3. MOUNTING BRACKETS NOT FURNISHED WITH SCALES UNLESS ORDERED.
4. GRADUATIONS SUPPLIED ON R.H. SIDE AS SHOWN UNLESS OTHERWISE SPECIFIED ON CUSTOMERS PO. GRADUATIONS ON BOTH SIDES OF SCALE WILL BE SUPPLIED WHEN SPECIFIED. (EXTRA CHARGE)

4	REDRAWN & UPDATED	7/27/92	
3	REDRAWN	4/10/84	
SYM	REVISION	DATE	APP

STANDARD SCALES
AND SCALE SUPPORTS

JERGUSON
GAGE & VALVE CO.
STRONGSVILLE, OHIO, U.S.A.
SCALE NONE DATE 7/27/92

DRAWN CMS	FILE NO. 4-385
CHECKED CEL	DRAWING NO. GD-1024
APPROVED	REV. 4